

HYDROCAL 1008

Multi-Gas-in-Oil Analysis System with Transformer Monitoring Functions



The HYDROCAL 1008 is a permanently installed multi-gas-in-oil analysis system with transformer monitoring functions. It individually measures, Moisture in Oil (H_2O) and the key gases Hydrogen (H_2), Carbon Monoxide (CO), Carbon Dioxide (CO_2), Methane (CH_4), Acetylene (C_2H_2), Ethylene (C_2H_4) and Ethane (C_2H_6) dissolved in transformer oil.

As Hydrogen (H_2) is involved in nearly every fault of the insulation system of power transformers and Carbon Monoxide (CO) is a sign of an involvement of the cellulosic / paper insulation the presence and increase of Acetylene (C_2H_2) and Ethylene (C_2H_4) further classifies the nature of a fault as overheating, partial discharge or high energy arcing.

The device can serve as a compact transformer monitoring system by the integration / connection of other sensors present on a transformer via its optional analog inputs:

- 4 Analog inputs 0/4 ... 20 mA DC
- 6 Analog inputs 0/4 ... 20 mA AC +20% or 0 ... 80 VAC +20% (configurable by jumpers)

It is further equipped with digital outputs for the transmission of alarms or the execution of control functions (e.g. control of a cooling system of a transformer):

- 8 digital relay outputs
- 5 digital optocoupler outputs (Option)

Key Advantages

- Individual measurement of Hydrogen (H_2), Carbon Monoxide (CO), Carbon Dioxide (CO_2), Methane (CH_4), Acetylene (C_2H_2), Ethylene (C_2H_4) and Ethane (C_2H_6)
- Moisture in Oil (H_2O) measurement
- Easy to mount on a transformer valve (G 1½" DIN ISO 228-1 or 1½" NPT ANSI B 1.20.1)
- Installation on the operational transformer without any operational interruption
- Advanced software (on the unit and via PC)
- Maintenance free system
- Communication interfaces ETHERNET 10/100 Mbit/s (copper-wired / RJ 45 or fibre-optical / SC Duplex) and RS 485 to support MODBUS®RTU/ASCII, MODBUS®TCP, DNP3 proprietary communication and IEC 61850 protocols
- Optional DNP3 software stack modem for SCADA connection
- Optional IEC 61850 software stack modem for SCADA connection
- Optional HV and LV bushing sensors for HV and LV bushing monitoring applications via communication interface

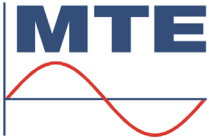

Transformer monitoring functions

Voltages and Currents

(via voltage and current transformers / transducer)

Temperature Monitoring

Bottom and top oil temperature, ambient temperature
(via additional temperature sensors)

Cooling Stage / Tap Changer Position

(e.g. via current transducer)

Free configuration

Analog inputs can be free allocated to any additional sensor

Further Calculations:

Hot-Spot (acc. IEC 60076) } joint development
 Loss-of-Life } with PAUWELS
 Ageing Rate } Belgium

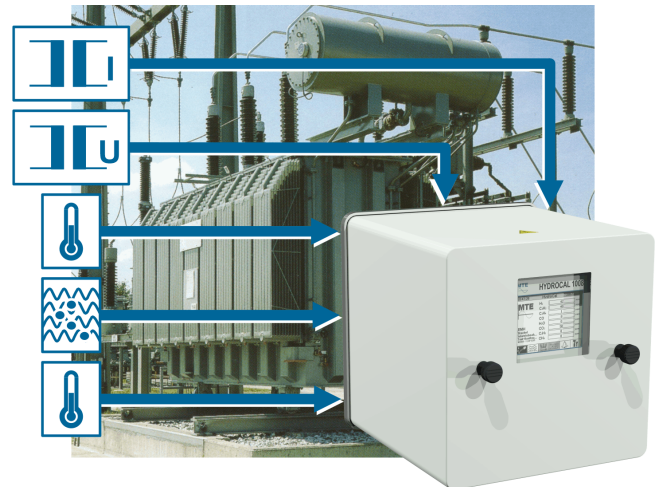

HV and LV Bushing monitoring functions (option)

HYDROCAL BPD is a modular online monitoring system for high voltage bushings. It supports the measurement of voltage and phase angle on the test tap to derive $\tan\delta$ /PF, bushing capacitance.

HYDROCAL BPD can be combined with other HYDROCAL models, preferably HYDROCAL genX, in order to set up a comprehensive monitoring system.

As per CIGRÉ Working Group A2.37 bushings resp. the lead exit represents the 2nd largest group of transformer failure locations (approx. 25%) after the windings (43%) and before the tap changers (23%). Therefore, bushing monitoring can help to reduce those failures. HYDROCAL BPD combined with online DGA performed by the HYDROCAL product family provides the ideal overall transformer monitoring solution.

The measurement of voltage and phase angle on the test tap of high voltage bushings allows to compare $\tan\delta$ /PF with factory test results for analysing deterioration of the bushings.

Key Advantages

- Monitoring of capacitance, $\tan\phi$ /PF of up to six high voltage bushings (1 up to 6 bushings)
- Advanced software (on the unit and via PC) with intuitive operation by 7" color TFT capacitive touchscreen, WLAN and Web-server operation from any smart phone, tablet or notebook PC
- Communication interfaces WiFi, USB or ETHERNET 10/100 Mbit/s
- SD memory of test results, history and diagnostic data of power transformers
- Maintenance free system

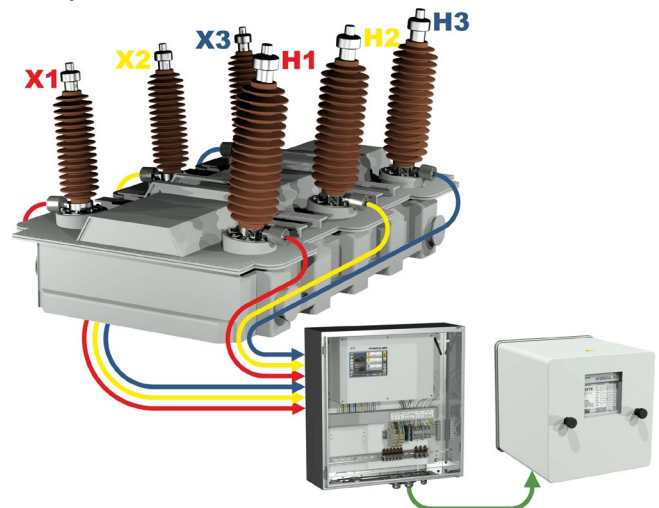

Monitoring of high- and low voltage side

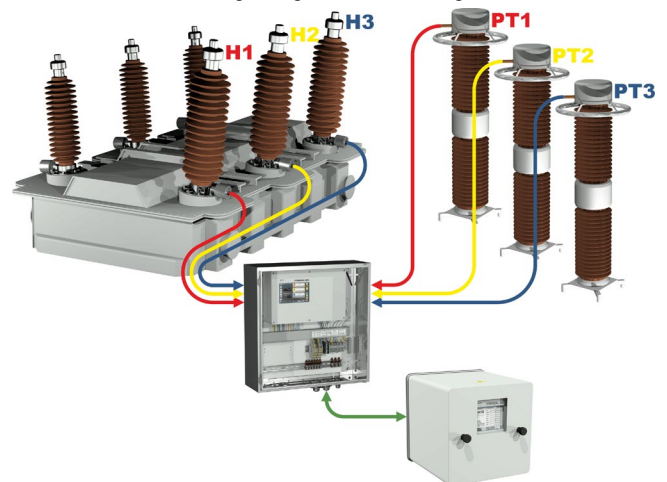

Reference CCVT / CCPT

HYDROCAL firmware main menu

1 Extraction status

- Shows the actual operating status of the unit

2 Gas-in-oil overview

- Column chart
- Trend graph
- Data table

3 Transformer specific measurements

- Trend graph
- Data table

(to be included)

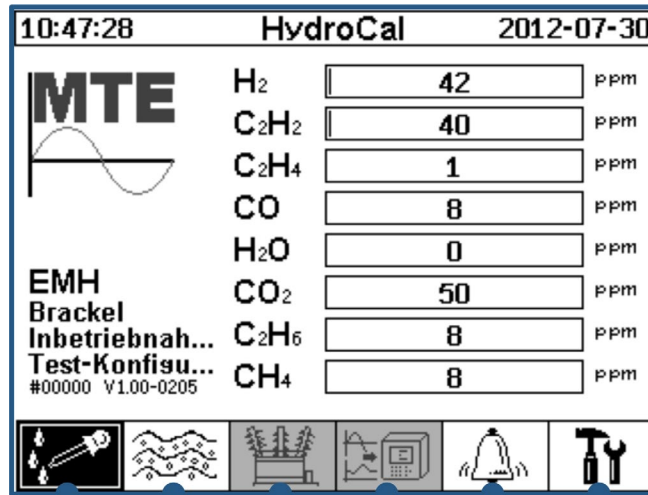

4 Additional sensor measurements

- Trend graph
- Data table

(to be included)

5 Alert overview

- Alert acknowledgement
- Alert table

6 Device setup

- Alert level setting
- Communication setting
- Transformer setting
- In- and output setting

Extraction status

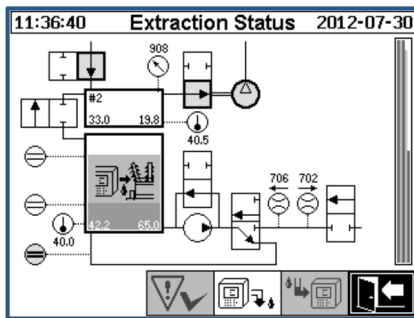

Shows the status of the actual process step and information of safety functions.

Gas-in-oil overview

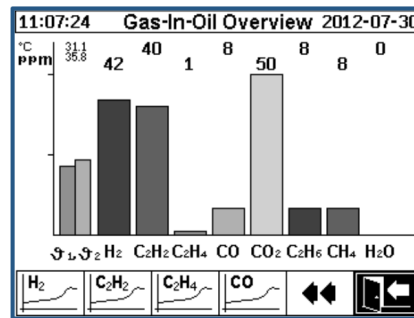

Individual chart diagram for Hydrogen (H₂), Carbon Monoxide (CO), Carbon Dioxide (CO₂), Methane (CH₄), Acetylene (C₂H₂), Ethylene (C₂H₄) and Ethane (C₂H₆) and Moisture in Oil (H₂O) and temperatures.

Alert overview

Selection of Alert			
#	Name	Date/Time	Status
1	H2-Alert	07-30 11:09	✓
2	CO-Alert	07-30 11:10	✓
3	CO2-Alert	07-30 11:10	✓
4	C2H2-Alert	07-30 11:12	✓
5	C2H4-Alert	07-30 11:12	✓
6	C2H6-Alert	07-30 11:13	✓
7	CH4-Alert	07-30 11:13	✓
8	H2O-Alert	07-30 11:14	✓

Display of alarm list. Details of each alarm and individual settings is shown.

HydroSoft PC-Software

Program key features

- Configuration and administration of each individual HYDROCAL unit
- Data and configuration read out of HYDROCAL units
- Processing and presentation of data read out (trend or table)
- Online functions (online sensors, extraction status and process flow)
- Diagnostic functions (Duval triangle and Rogers 3D graphic)
- Further processing of the processed data (Excel, CSV, clipboard and printing)
- Storage of the processed data and unit configuration
- Automatic data read out and alerting by e-mail

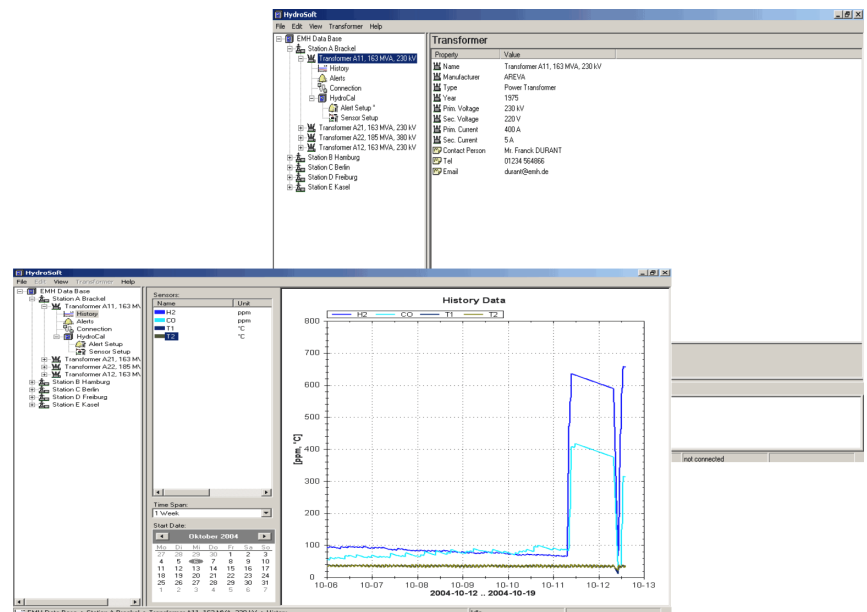

Technical data HYDROCAL 1008

General

Optional nominal voltages of auxiliary supply:	120 V -20% +15% AC 50/60 Hz ¹⁾ or 230 V -20% +15% AC 50/60 Hz ¹⁾ or 120 V -20% +15% DC ¹⁾ or 230 V -20% +15% DC ¹⁾ Other nominal voltages on request!
Power consumption:	max. 600 VA
Housing:	Aluminium
Dimensions:	W 263 x H 274 x D 331 mm
Weight:	approx. 15 kg
Operation temperature: (ambient)	-55°C ... +55°C (below -10°C display function locked)
Oil temperature: (in the transformer)	-20°C ... +90°C
Storage temperature: (ambient)	-20°C ... +65°C
Oil Pressure:	0 - 800 kpa (negative pressure allowed)
Connection to valve:	G 1½" DIN ISO 228-1 or 1½" NPT ANSI B 1.20.1

Safety

Insulation protection:	IEC 61010-1
Degree of protection:	IP-55

Measurements

Gas/Moisture in oil Measurement		Accuracy ^{2) 3)}
Measuring quantity	Range	
Hydrogen H ₂	0 ... 2.000 ppm	± 15 % ± 25 ppm
Carbon Monoxide CO	0 ... 5.000 ppm	± 20 % ± 25 ppm
Carbon Dioxide CO ₂	0 ... 20.000 ppm	± 20 % ± 25 ppm
Methane CH ₄	0 ... 2.000 ppm	± 20 % ± 25 ppm
Acetylene C ₂ H ₂	0 ... 2.000 ppm	± 20 % ± 5 ppm
Ethylene C ₂ H ₄	0 ... 2.000 ppm	± 20 % ± 10 ppm
Ethane C ₂ H ₆	0 ... 2.000 ppm	± 20 % ± 15 ppm
Moisture H ₂ O (aw)	0 ... 100 %	± 3 %
Moisture in Mineral Oil	0 ... 100 ppm	± 3 % ± 3 ppm
Moisture in synt. Ester ⁵⁾	0 ... 2.000 ppm	± 3 % of MSC ⁶⁾

⁵⁾Option ⁶⁾ Moisture Saturation Content

Operation principle

- Miniaturized gas sample production based on headspace principle (no membrane, negative pressure proofed)
- Patent-pending oil sampling system (EP 1 950 560 A1)
- Near-infrared gas sensor unit for CO, C₂H₂ and C₂H₄
- Near-infrared gas sensor unit for CO₂, CH₄ and C₂H₆
- Micro-electronic gas sensor for H₂
- Thin-film capacitive moisture sensor H₂O
- Temperature sensors (for oil and gas temperature)

Connections



Analog and digital outputs

8 x Analog DC outputs		Default concentration (Free assignment)
Type	Range	
1 x Current DC	0/4 ... 20 mADC	Hydrogen H ₂
1 x Current DC	0/4 ... 20 mADC	Acetylene C ₂ H ₂
1 x Current DC	0/4 ... 20 mADC	Ethylene C ₂ H ₄
1 x Current DC	0/4 ... 20 mADC	Carbon Monoxide CO
1 x Current DC	0/4 ... 20 mADC	Moisture in Oil H ₂ O
1 x Current DC	0/4 ... 20 mADC	Carbon Dioxide CO ₂
1 x Current DC	0/4 ... 20 mADC	Ethane C ₂ H ₆
1 x Current DC	0/4 ... 20 mADC	Methane CH ₄

8 x Digital outputs		Max. Switching capacity (Free assignment)
Type	Control voltage	
8 x Relay	12 VDC	220 VDC/VAC / 2 A / 60 W

Analog inputs and digital outputs (option)

6 x Analog AC inputs		Accuracy of the measuring value	Remarks
Type	Range		
6 x Current AC or 6 x Voltage AC	0/4 ... 20 mA +20% or 0 ... 80 V +20%	≤ 1.0 %	Configurable by jumpers ⁴⁾

4 x Analog DC inputs		Accuracy of the measuring value	Remarks
Type	Range		
4 x Current DC	0/4 ... 20 mADC	≤ 0.5 %	

5 x Digital outputs		Max. Switching capacity (Free assignment)
Type	Control Voltage	
5 x Optocoupler	5 VDC	U _{CE} : 24 V rated / 35 V max. U _{EC} : 7 V max. I _{CE} : 40 mA max.

Communication

- RS 485 (proprietary or MODBUS[®] RTU/ASCII protocol)
- ETHERNET 10/100 Mbit/s copper-wired / RJ 45 or fibre-optical / SC Duplex (proprietary or MODBUS[®] TCP protocol)
- DNP3 software stack modem (Option)
- IEC 61850 software stack modem (Option)

Notes

- 1) 120 V ⇒ 120 V -20% = 96 V_{min} 120 V +15% = 138 V_{max}
230 V ⇒ 230 V -20% = 184 V_{min} 230 V +15% = 264 V_{max}
- 2) Related to temperatures ambient +20°C and oil +55°C
- 3) Accuracy for moisture in oil for mineral oil types
- 4) Default jumper configuration: Current